

1 2 3 4 5 6

A

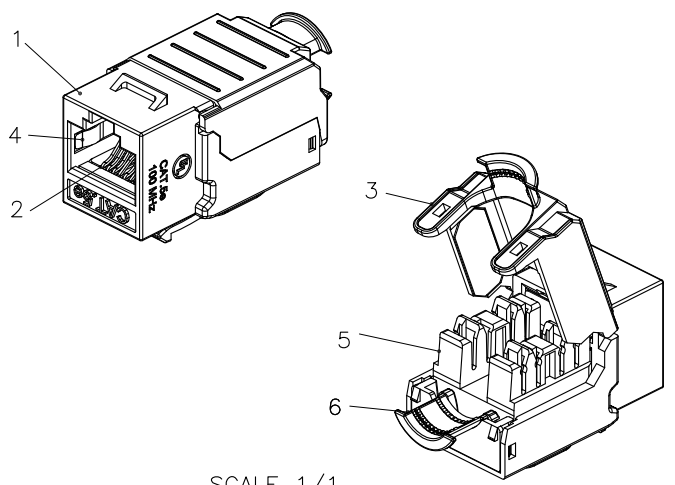

SCALE 1/1

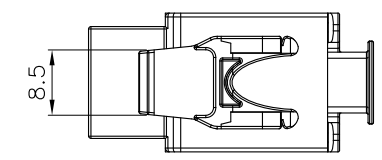
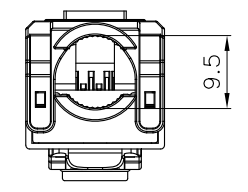
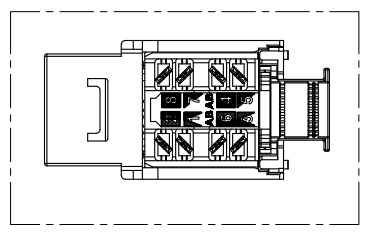
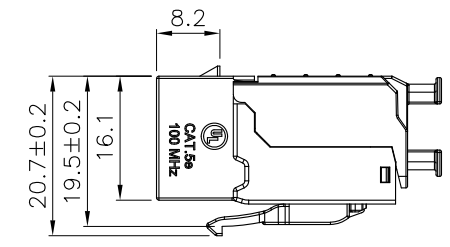
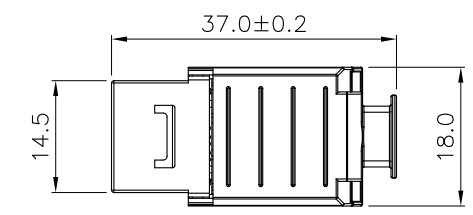
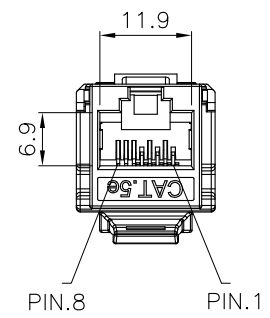

B

C

D

Specification :

Material :

1. RJ45 Jack :
 - 1-1. Housing : Zinc Die-Casting with Nickel plated.
 - 1-2. Contact Bracket : PBT+Glass Fiber, UL 94V-0, with black color.
2. RJ45 Jack Contact :
 - 2-1. Material : Phosphor Bronze with Nickel plated.
 - 2-2. Finish : 50 micro-inch Gold plated on Plug contact area.
3. Cap : Zinc Die-Casting with Nickel plated.
4. Clip : Stainless Steel.
5. IDC :
 - 5-1. Housing : PC+Glass Fiber, Grey color(RAL7035), UL 94-V2.
 - 5-2. Terminal : Phosphor Bronze with Tin plated.
6. Grounding Contact : Zinc Die-Casting with Nickel plated.
7. PCB : FR4, UL 94-V0.

Performance :

- a. T568A & T568B wiring.
- b. Insertion Force : 30N max. (IEC 60603-7-5).
- c. Retention Strength : 7.7 kg between Jack and Plug.
- d. Operating Temperature : -10°C to 60°C. (ISO/IEC 11801, ANSI/TIA 568 C.2).
- e. Life(mating cycles) :
 - e-1. Jack : 750 cycles min. (ISO/IEC 11801, IEC 60603-7-5).
 - e-2. IDC : Suitable for 23-26 AWG stranded and solid wire, compatible with 110 punch down tool.
- f. The Cat.5e performance is in compliance with the ANSI/TIA 568 C.2 standard.



GENERAL TOLERANCE OF DIMENSIONS X.XXX ±0.005 X.XX ±0.05 X.X ±0.1	DRAWING	04.JUL.2014	WESLEY	JYH ENG TECHNOLOGY CO.,LTD
	CHECK	04.JUL.2014	DAY	
	APPROVAL	04.JUL.2014	JAIMY	
	DATE		NAME	
SCALE	1/1 (A4)	UNIT	mm	DES.: CAT.5e FULL SHIELDED KEYSTONE JACK
		DRAWING NO. AADCD0211303015 KJ32-CE-FS(SA4)		
		DRAWING CLASSIFICATION	S SHEET	

1 2 3 4 5 6

10cm